

U1

Dispense Options



Chilled



Ambient

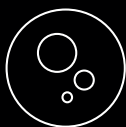

Sparkling

Contents

Component/Feature Overview

Operation

Functions & Controls

General Safety

CO2 Bottle Installation

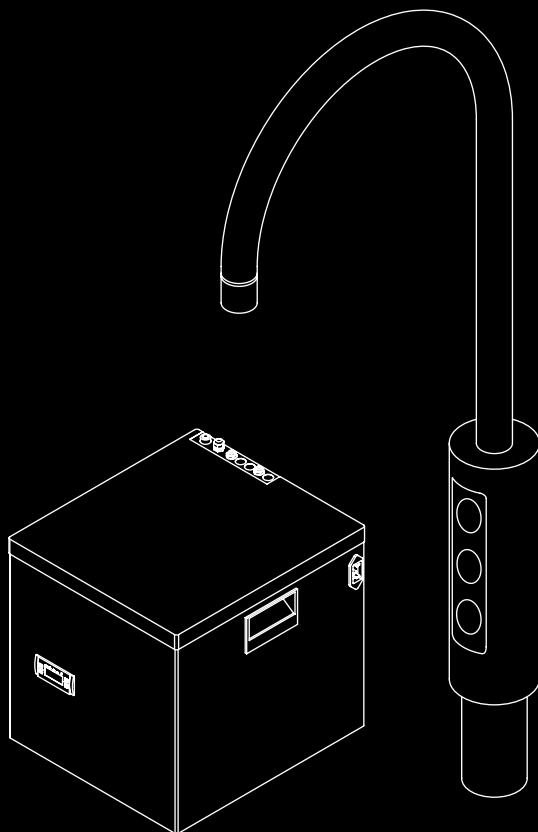

Component/ Feature Overview

U1 Tap - Major Components

Contents:

- 1 no Electronic Swan Neck Tap
- 1 no 2/3-Button Membrane Control Panel
- 1 no 1.0m x 6mm Insulated Water Pipe
- 1 no Connector Box
- 1 no 4mm Self Adhesive Clip
- 1 no Fixings Set

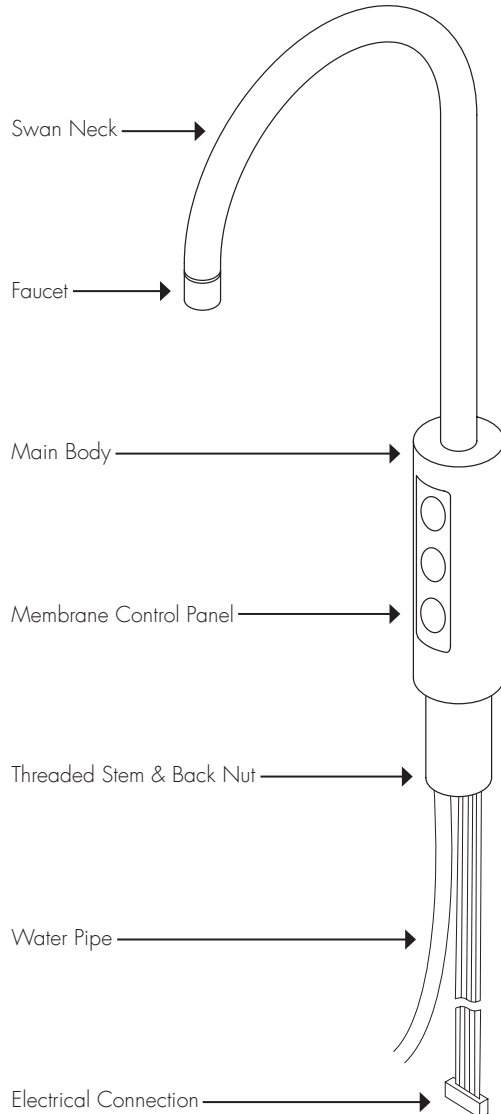

Please Note:

Mains Installation Kit & Filters are supplied as extra items according to individual ordering requirement.

S2 Undercounter - Major Components

Contents:

- 1 no Undercounter Unit
- 1 no 2.0m Power Cord Set
- 1 no 1.0m Faucet Connection Harness
- 1 no Co2 Regulator with Gauge & Connection tube*
- 1 no Stainless Steel Drip Tray (c/w with Drain Outlet Cap)
- 1 no Simple Vent Kit

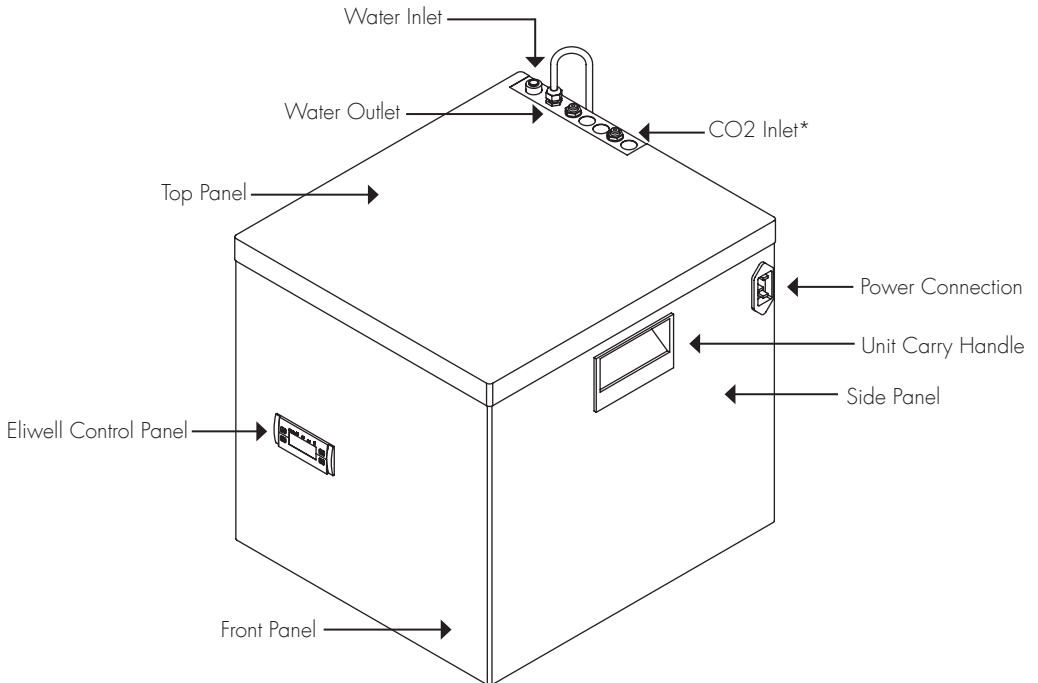
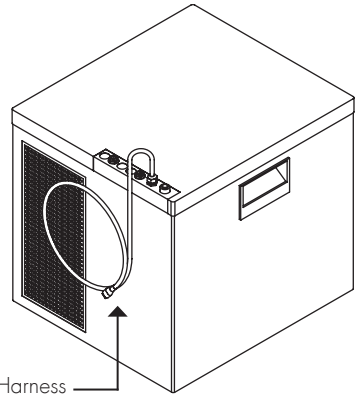

*Sparkling versions only.

Operation

Eliwell Control Panel

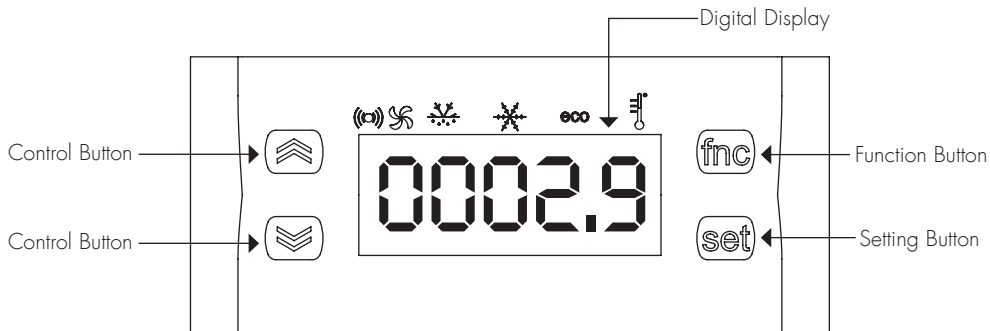

Basic Settings

Adjusting the Set Point:

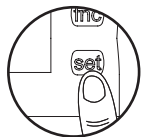

1. Switch on Mains power – the display will flash several times, then the fridge system will switch on and the display will give a steady reading, this is the temperature of the water tanks sensor.
2. Press and release the 'Set' button – The display will show 'SET'.
3. Press 'Set' again and the display will show a numeric value (e.g. 9°C).
4. Raise or lower this figure to the desired setting using the up or down arrows on the left of the control display window.
5. When the correct setting is shown in the display window press 'Set' button the display will now show SET.
6. Press FNC button to return to the probe temperature reading.



Functions & Controls

Tap Control Panel

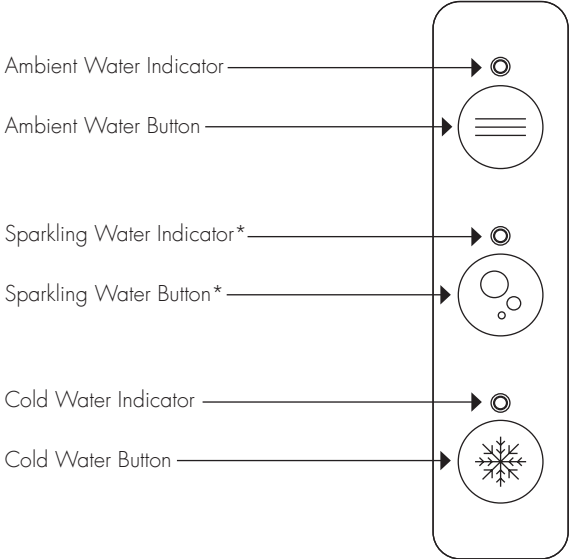

*Sparkling versions only.

Controls

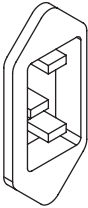

Power Connection Socket

Note: the undercounter unit automatically powers up when the power lead is connected.

General Safety

General Safety

- Always place the dispenser in its vertical position, on a surface which can capably support its weight.
- During use this machine must remain in its upright position.
- Adequate ventilation must be allowed for - we recommend using the supplied ventilation ducting kit.
- Keep the machine away from sunlight, heat and moisture.
- The environment where this machine is installed must be free of dust and corrosive/explosive gases.

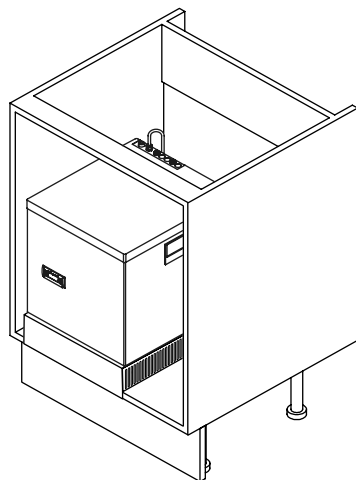

Basic Troubleshooting

Problem/Report	Possible Cause	Suggested Action
No Water Dispensing	Water Pressure Regulator	Contact your distributor.
No Sparkling Water - If applicable	No CO2 pressure, check by operating pressure relief valve on carbonator tank.	Check CO2 bottle, regulator and non-return valve. Supply pressure should be 58 psi (4bar), adjust or replace as necessary.
	Carbonator Tank Not Filling	Contact your distributor.
Poor Quality Carbonation - If applicable	Incorrect CO2 Pressure	Check CO2 bottle, regulator and non-return valve. Supply pressure should be 58 psi (4bar), adjust or replace as necessary.
	Air in Carbonator Tank	Isolate the power supply and operate the sparkling water tap until gas is expelled. Allow gas to expel for 5 seconds. Switch on power supply and allow the tank to refill.
	Residue in Carbonator Tank	After prolonged use, a surface film can develop within the carbonator tank. Refer to cleaning and sanitising instructions.
	Carbonator Tank is Overfilled	If pump runs continuously, contact your distributor.
Warm Drinks	Insufficient cooling air flow through the fridge.	Contact your distributor.
	Compressor not running.	
	Eliwell fridge controller not operating.	
	PCB not operating.	
	Fridge failure.	

CO2 Bottle Installation - Sparkling Versions Only

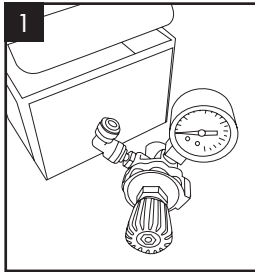

Unpack CO2 Regulator and fit elbow fitting to spigot outlet.

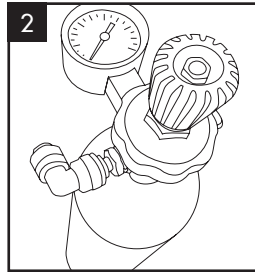

Attach the regulator to the disposable CO2 bottle, ensuring the pressure relief vent is facing away from you. Ensure the regulator is closed.

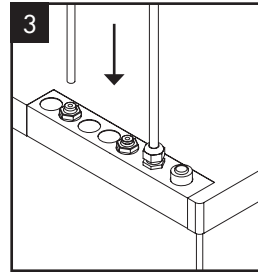

Connect the assembled CO2 bottle and regulator to the CO2 inlet using a 1/4" pipe.

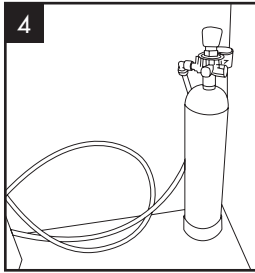

Stand the cylinder in a suitable place.

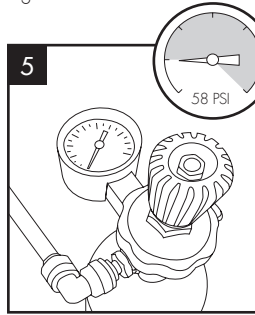

We recommend between 3.5 - 4 bar (58 PSI) (max). Do not exceed 4 bar pressure.

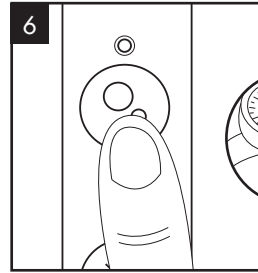

It is necessary to prime the sparkling system - push the sparkling button for a few seconds until CO2 is coming through. Check and adjust the CO2 pressure accordingly.

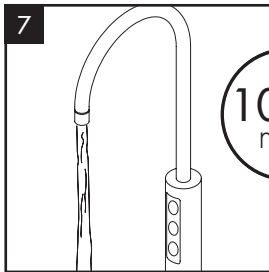

Allow the machine to stand for 8 - 12 minutes for the initial chilling process to complete.

For full distributor
service manual
visit:

[www.borgandoverstrom.com/
dealer/service-manuals](http://www.borgandoverstrom.com/dealer/service-manuals)



For user guides
for parts and
accessories visit:

[www.borgandoverstrom.com/
en/support/userguides/
accessories](http://www.borgandoverstrom.com/en/support/userguides/accessories)



For warranty visit:

[https://www.borgandoverstrom.
com/en/support/warranty/](https://www.borgandoverstrom.com/en/support/warranty/)



Customer services:
aftersales@borgandoverstrom.com
call +44 1362 695 006

Telephone
+44 (0)1362 695 006
Email
sales@borgandoverstrom.com

borgandoverstrom.com

© Copyright Borg & Overström.
This guide is printed by Borg & Overström and
shall not be reproduced or copied in anyway.

Ref: 838022
Version: 2